REPAIRABLE SYSTEMS

Repairable Systems

Maintenance defines the set of actions performed on the item to retain it in or to restore it to a specified state.

Thus, maintenance deals with

- preventive maintenance, carried out at predetermined intervals, e.g. to reduce wear-out failures,
- corrective maintenance, carried out at failure and intended to bring the item to a state in which it can perform the required function.

Repairable Systems

The goal of a preventive maintenance must also be to *detect & repair hidden failures & defects* (e.g. undetected failures in redundant elements).

Corrective maintenance, also known as repair, includes *detection, localization, correction, and checkout*.

To simplify the calculations, it is generally assumed that the item for which a maintenance action has been performed, is *as-good-as-new* after maintenance.

Repairable Systems

It is also assumed that each failed item in the multicomponent systems is repaired by individual repairman, i.e. all failed items are repaired simultaneously.

Item's time to repair is regarded as a continuous random variable.

The mean of the repair time is denoted by *MTTR* (*mean time to repair (restoration)*).

Repairable Systems

Just like failure probability in non-repairable systems, the probability of repair grows with time.

We will further assume that time to repair is an exponentially distributed random variable, which means that repair rate – a measure analogous to the failure rate – is a constant number, μ .

$$\text{Thus, } MTTR = \frac{1}{\mu}.$$

Repairable Systems

Availability is a broad term, expressing the ratio of delivered to expected service.

It is often designated by A and used for the asymptotic & steady-state value of the *point availability*.

Point availability ($PA(t)$) is a characteristic of the item expressed by the probability that the item will perform its required function under given conditions at a stated instant of time t .

Repairable Systems

Availability calculation is often difficult, as human aspects & logistic support have to be considered. Ideal human aspects & logistic support are often assumed, yielding to the intrinsic availability.

Further assumptions for calculations are continuous operation and complete renewal of the repaired element.

In this case, the point availability of the one-item structure rapidly converges to an asymptotic & steady-state value, given by

$$A = \frac{MTTF}{MTTF + MTTR}$$

Repairable Systems

Ex.: Consider a single-item system, assuming that the following corrective maintenance strategy is adopted:

When the system fails, a repair action is initiated to bring it back to its initial functioning state. After the repair is completed, the system is assumed to be as-good-as-new.

We also assume that the system has constant failure rate λ and constant repair rate μ .



Repairable Systems

To evaluate the point availability of the system, a space-state method should be exploited. In order to do that, we need to compose a graph – a *state-transition diagram*.

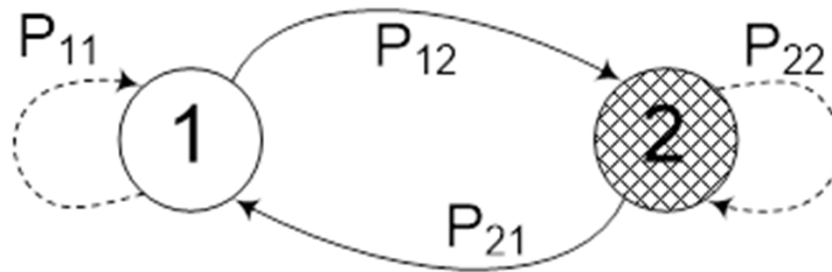

In the diagram circles represent system's states and arcs correspond to transitions from one state to another.



Repairable Systems

We denote an operable state as a state 1, and a failed state as 2.

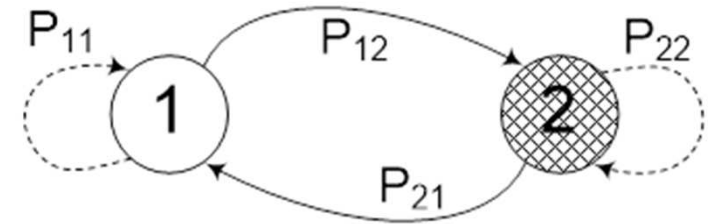

At any single moment there is a probability that the system would transit from its current state to another one (P_{12} and P_{21}), and, also, that the system remains in its current state (P_{11} and P_{22}).

By definition, P_{12} is the instantaneous failure probability, and P_{21} – instantaneous repair probability.



Repairable Systems

Further calculations do not involve probabilities P_{ij} , so we won't draw loops in graphs anymore.

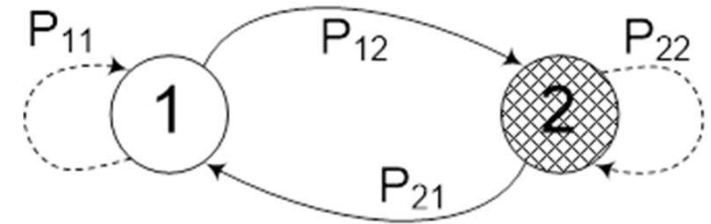

For any given state i the sum of P_{ij} adds up to 1.

State probabilities are obtained then by the following system of equations:

$$\begin{cases} P_1(t + \Delta t) = P_1(t) \cdot [1 - P_{12}(\Delta t)] + P_2(t) \cdot P_{21}(\Delta t) \\ P_2(t + \Delta t) = P_2(t) \cdot [1 - P_{21}(\Delta t)] + P_1(t) \cdot P_{12}(\Delta t) \end{cases}$$

In order to simplify the explanation, we will refer to the moment t as to “now”, and to the moment $t+\Delta t$ as to “next moment”.



Repairable Systems

Then, the first equation is explained as follows:

$$P_1(t + \Delta t) = P_1(t) \cdot [1 - P_{12}(\Delta t)] + P_2(t) \cdot P_{21}(\Delta t)$$

The probability that the system will find itself in the next moment in state 1 is equal to...

... the probability that it is already in state 1 and it won't transit to state 2 during time interval Δt ...

... plus the probability that now the system is in state 2 and it will transit to state 1 during time interval Δt .



Repairable Systems

As Δt approaches to 0, $P_{ij}(\Delta t) \rightarrow \gamma_{ij}\Delta t$, where γ_{ij} is the transient rate.

Using the definition of derivative we obtain:

$$\begin{cases} P_1'(t) = -\lambda P_1(t) + \mu P_2(t) \\ P_2'(t) = \lambda P_1(t) - \mu P_2(t) \end{cases}$$

since $\gamma_{12} = \lambda$ and $\gamma_{21} = \mu$.

We also can obtain such a system directly from the state-transition diagram



Repairable Systems

For each state in the diagram we have an equation with the derivative of the state probability on the left.

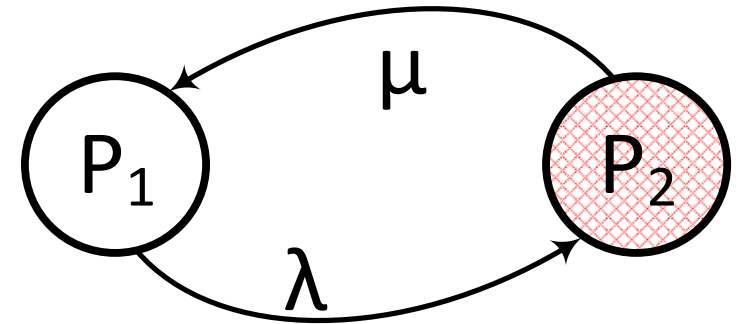

On the right side we have as many terms as the number of arcs adjacent to a current state.

Each arc is represented by its **rate** times **the probability of the originate state**.

The terms corresponding to incoming arcs go with “+” sign, outgoing arcs – with “-”.



Repairable Systems

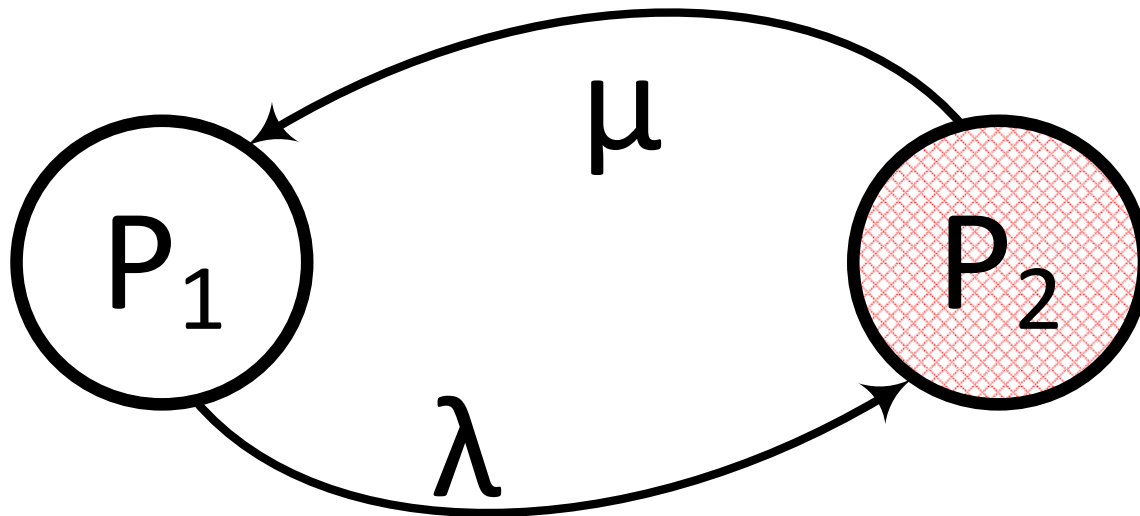

$$\begin{cases} P_1'(t) = -\lambda P_1(t) + \mu P_2(t) \\ P_2'(t) = \lambda P_1(t) - \mu P_2(t) \end{cases}$$



Repairable Systems

$$\begin{cases} P_1'(t) = -\lambda P_1(t) + \mu P_2(t) \\ P_2'(t) = \lambda P_1(t) - \mu P_2(t) \end{cases}$$

To solve this system we can use Laplace transform method, taking into account that

$$\begin{aligned} P(t) &\stackrel{\mathcal{L}}{\Rightarrow} P(s) \\ P'(t) &\stackrel{\mathcal{L}}{\Rightarrow} sP(s) - P(0^+) \end{aligned}$$

Assuming that at time 0 the system is in state 1, we get:

$$\begin{cases} sP_1(s) = -\lambda P_1(s) + \mu P_2(s) + 1 \\ sP_2(s) = \lambda P_1(s) - \mu P_2(s) + 0 \end{cases}$$



Repairable Systems

$$\begin{cases} sP_1(s) = -\lambda P_1(s) + \mu P_2(s) + 1 \\ sP_2(s) = \lambda P_1(s) - \mu P_2(s) \end{cases}$$

From the second equation:

$$P_2(s) = \frac{\lambda}{s + \mu} P_1(s)$$

Substituting this result into the first equation, we get:

$$P_1(s) = \frac{s + \mu}{s(s + \lambda + \mu)} \quad P_2(s) = \frac{\lambda}{s(s + \lambda + \mu)}$$



Repairable Systems

$$\begin{cases} sP_1(s) = -\lambda P_1(s) + \mu P_2(s) + 1 \\ sP_2(s) = \lambda P_1(s) - \mu P_2(s) \end{cases}$$

Inverse Laplace transform allows us to return into time domain:

$$P_1(t) = \mathcal{L}^{-1}\{P_1(s)\} = \frac{\mu}{\lambda + \mu} + \frac{\lambda}{\lambda + \mu} e^{-(\lambda + \mu)t}$$

$P_1(t)$ is the probability that the system is in operable state, which, by definition, is the point availability $PA(t)$ of the repairable system.



Repairable Systems

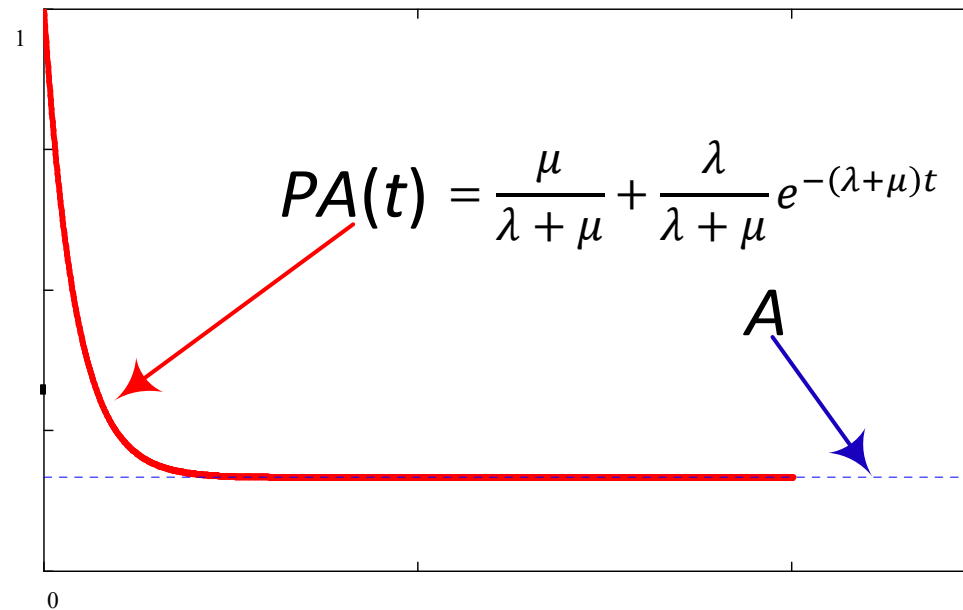

As $\frac{\lambda}{\lambda + \mu} e^{-(\lambda + \mu)t}$ rapidly tapers down to 0, $PA(t)$ approaches the value

$$A = \frac{\mu}{\lambda + \mu} = \frac{MTTF}{MTTF + MTTR}$$



Repairable Systems

Since usually $\mu \gg \lambda$, $PA(t)$ reaches its steady-state value very fast. So, instead of solving differential equations, we can obtain a steady-state solution a lot easier.

To achieve this, we replace all derivatives with zeros and supplement the system with an additional equation:

$$\begin{cases} 0 = -\lambda P_1 + \mu P_2 \\ 0 = \lambda P_1 - \mu P_2 \\ P_1 + P_2 = 1 \end{cases}$$

Solving this, we obtain $A = P_1$.

Repairable Systems

The major drawback of the state-space method is an avalanche-like increase of the number of states (and in turn, the number of equations) with increase of system complexity (number of components).

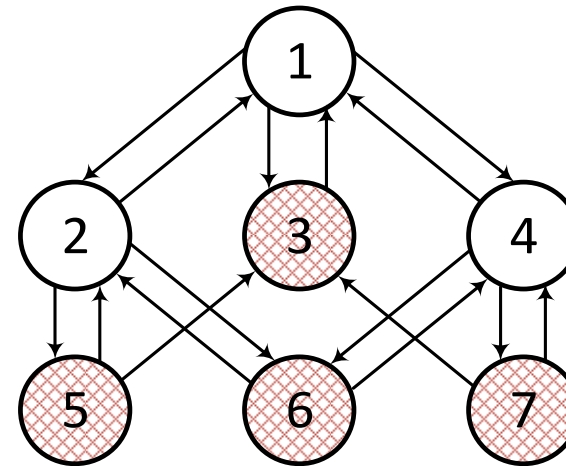
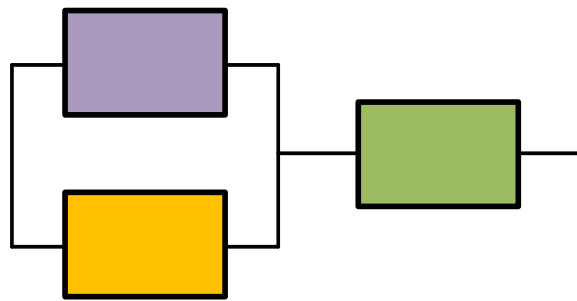

Repairable Systems

Sometimes the number of states can be reduced.

Usually, it is possible if components have the *same failure and/or repair rate* (which is common in parallel configurations).

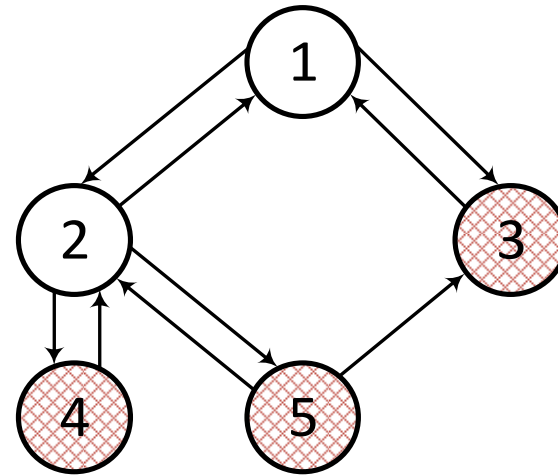
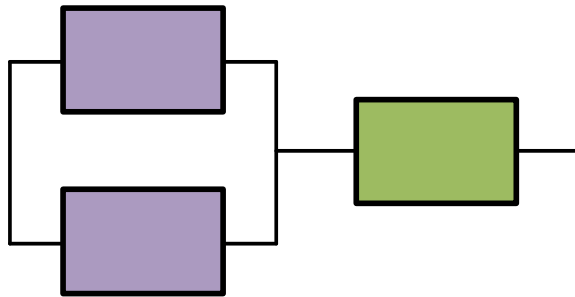

Repairable Systems

Ex.: Consider a system of 2 components in parallel (hot redundancy). Draw the state-transition diagram for 2 different cases:

- both components have different failure and repair rates;
- both components are identical.

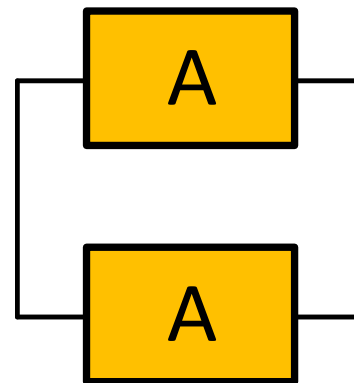
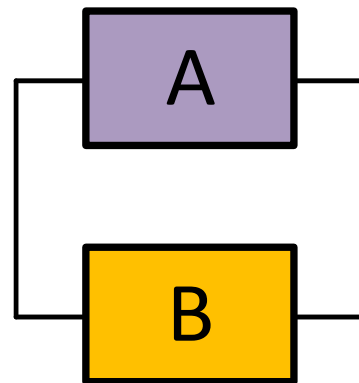

Repairable Systems

Starting from the initial state 1 in the first case, two events may happen: either component A or component B may fail (states 2 and 3). Those events are not the critical ones – the system is still in operable state.

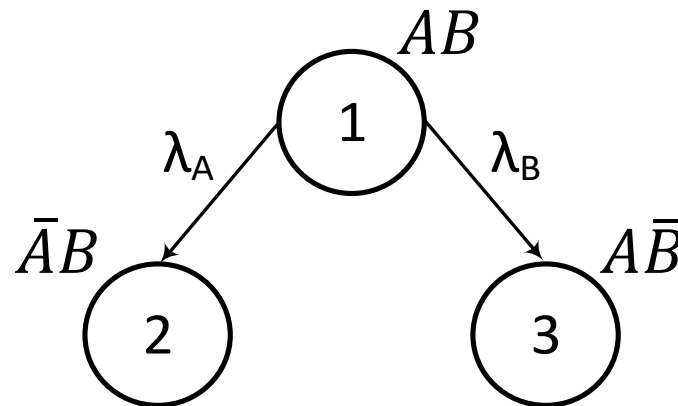
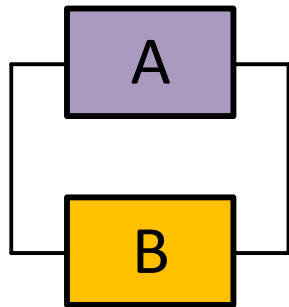

Repairable Systems

Failed components may be repaired, which return the system into the initial state.

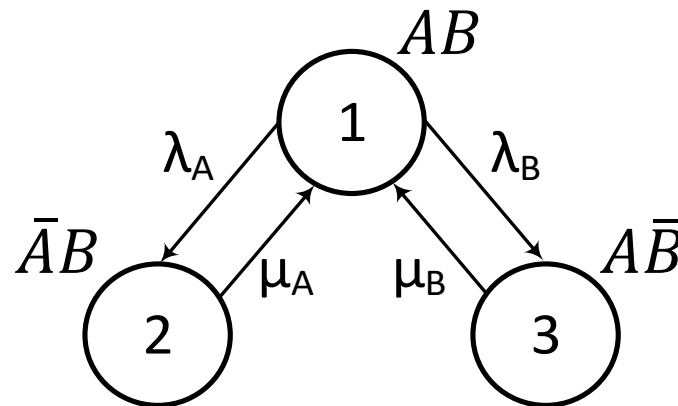
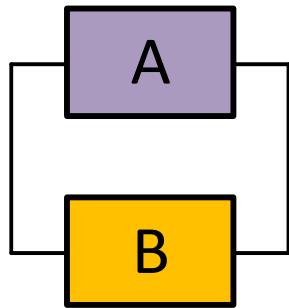

Repairable Systems

Components still operating in states 2 and 3 may fail as well, thus causing system failure (state 4).

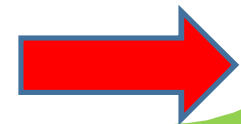
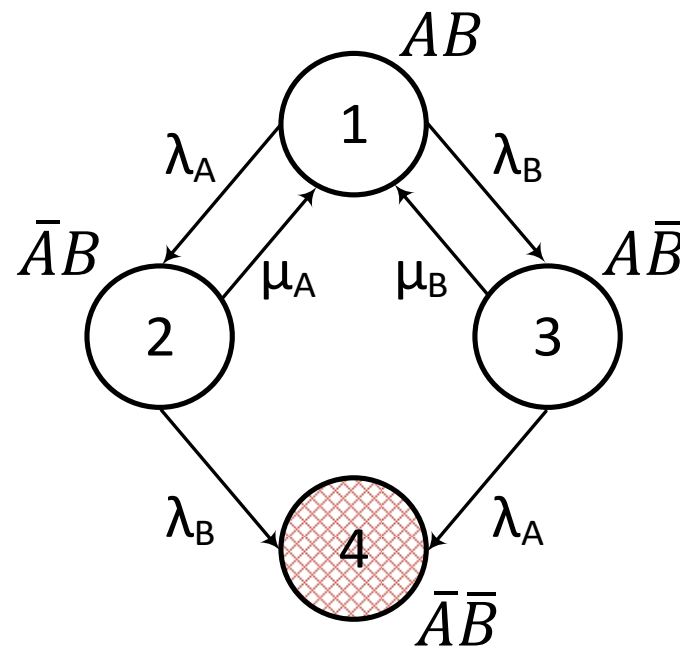
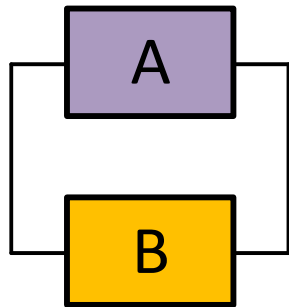

Repairable Systems

Finally, failed components from state 4 may be repaired, returning the system into states 2 or 3.

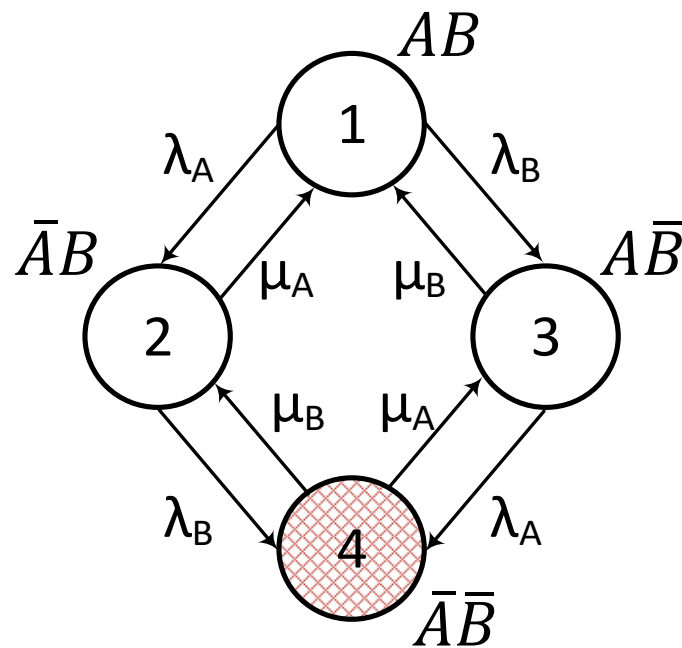
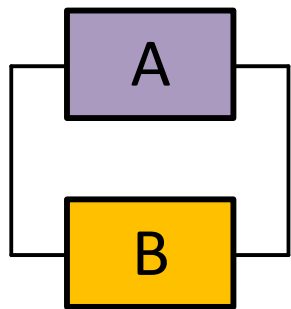

Repairable Systems

Note that each arc corresponds to a single failure/repair event –
no two events can occur simultaneously!

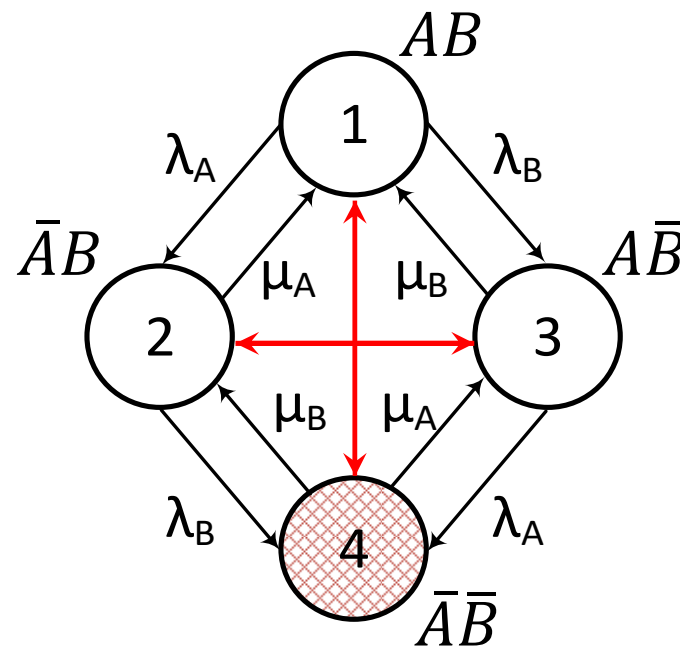
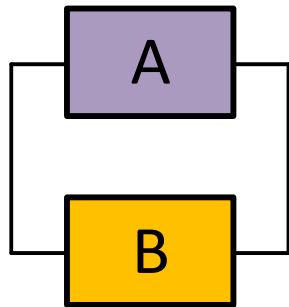

Repairable Systems

Since the components in the second case are statistically identical, it is irrelevant which item fails first – the consequences for the system are the same.

The transition rate is $2\lambda_A$ which indicates joint “effort” of both items to transfer the system into state 2.

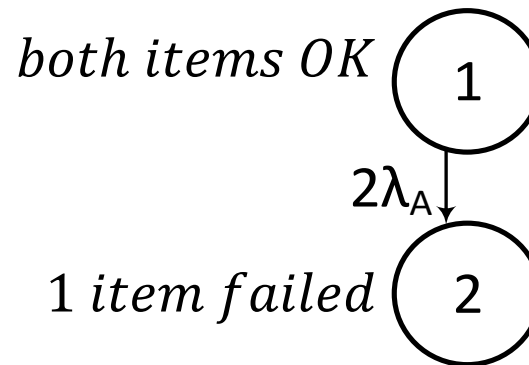
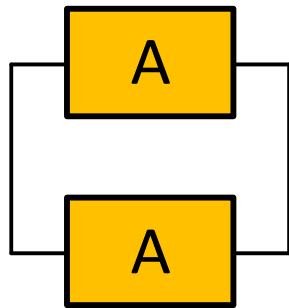

Repairable Systems

However, only one failed item is under repair in state 2, so the rate of reverse transition is still μ_A .

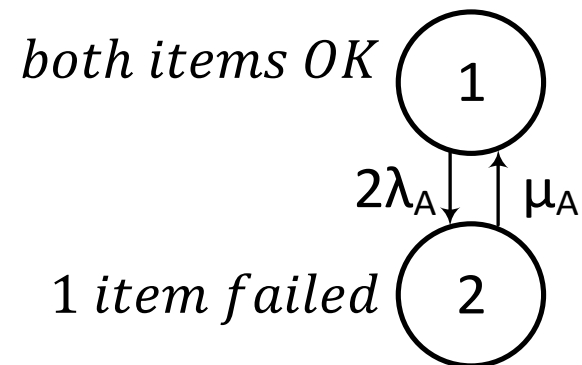
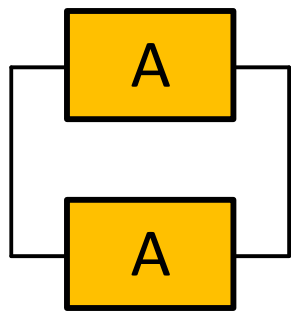

Repairable Systems

State 2 still has one operable component that may fail, resulting in system failure.

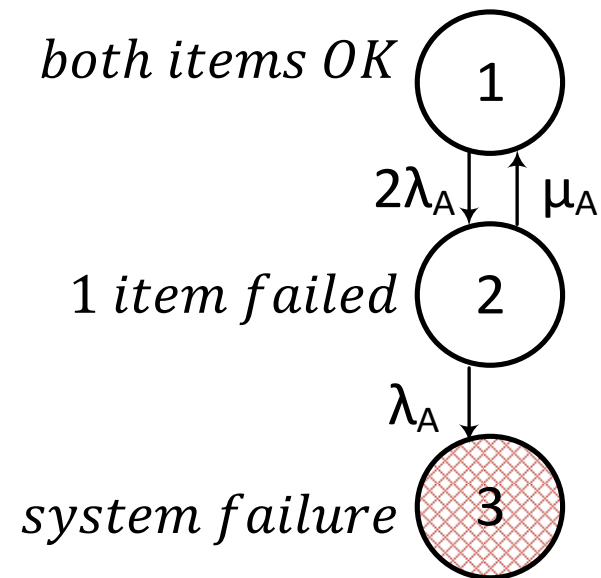
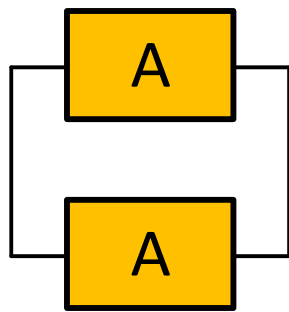

Repairable Systems

State 3 has two failed components, each being repaired individually by separate repairman. So, the rate of joint “effort” of returning back to state 2 is $2\mu_A$.

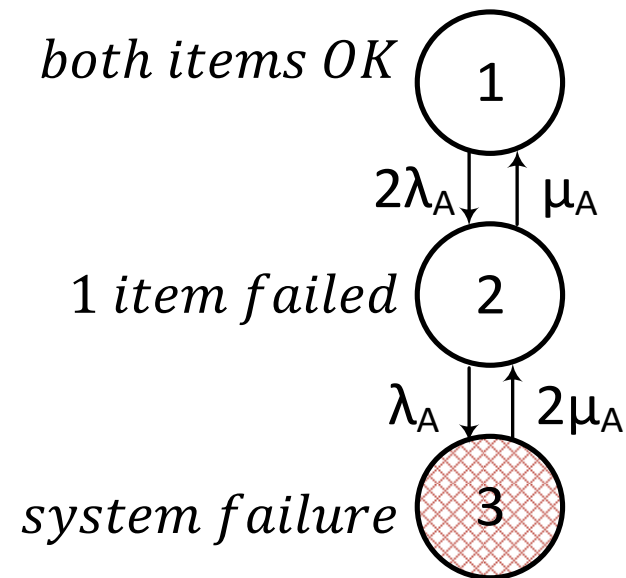
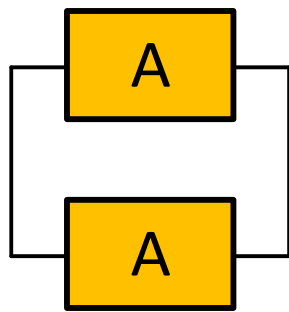

Repairable Systems

To find the point availability of the system we can perform the computation manually, which is rather tedious.

$$\begin{cases} sP_1(s) = -2\lambda_A P_1(s) + \mu_A P_2(s) + 1 \\ sP_2(s) = 2\lambda_A P_1(s) - (\lambda_A + \mu_A)P_2(s) + 2\mu_A P_3(s) \\ sP_3(s) = \lambda_A P_2(s) - 2\mu_A P_3(s) \end{cases}$$

Here, $PA(t) = P_1(t) + P_2(t) = 1 - P_3(t)$

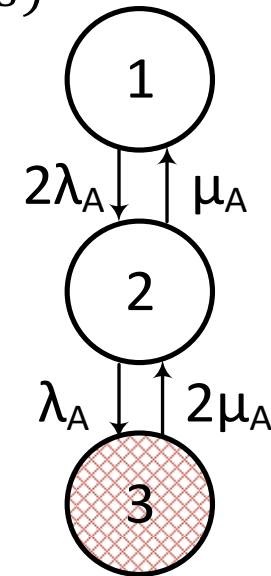

Repairable Systems

Alternatively, we can resort to a mathematical software:

$$A(s) := \begin{pmatrix} s + 2\lambda & -\mu & 0 \\ -2\lambda & s + \lambda + \mu & -2\mu \\ 0 & -\lambda & s + 2\mu \end{pmatrix} \quad B := \begin{pmatrix} 1 \\ 0 \\ 0 \end{pmatrix} \quad P(s) := A(s)^{-1} \cdot B$$

$$P(s) \begin{array}{l} \text{simplify} \\ \text{factor} \end{array} \rightarrow \begin{bmatrix} \frac{2 \cdot \mu^2 + 3 \cdot \mu \cdot s + s^2 + \lambda \cdot s}{s \cdot (2 \cdot \mu + 2 \cdot \lambda + s) \cdot (\mu + \lambda + s)} \\ \frac{2 \cdot \lambda \cdot (2 \cdot \mu + s)}{s \cdot (2 \cdot \mu + 2 \cdot \lambda + s) \cdot (\mu + \lambda + s)} \\ \frac{2 \cdot \lambda^2}{s \cdot (2 \cdot \mu + 2 \cdot \lambda + s) \cdot (\mu + \lambda + s)} \end{bmatrix} \begin{array}{l} P_1(s) \\ P_2(s) \\ P_3(s) \end{array}$$



Repairable Systems

However, if our goal is only to find the steady-state availability, we can achieve it easily with the following equations:

$$P_i = \frac{\lambda_{i-1,i}}{\mu_{i,i-1}} P_{i-1}$$

$$P_i = \frac{\prod_{j=1}^{i-1} \lambda_{j,j+1}}{\prod_{j=1}^{i-1} \mu_{j+1,j}} P_1$$

$$\sum P_i = 1$$

$$P_2 = \frac{2\lambda_A}{\mu_A} P_1$$

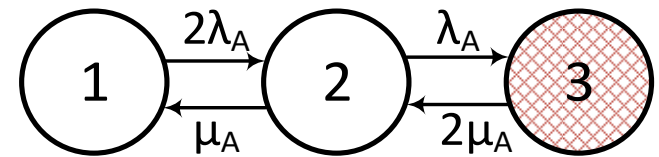

$$P_3 = \frac{\lambda_A}{2\mu_A} P_2 = \frac{2\lambda_A \cdot \lambda_A}{2\mu_A \cdot \mu_A} P_1 = \frac{\lambda_A^2}{\mu_A^2} P_1$$



Repairable Systems

Please, note that this technique is applied **only** in cases, when state transition diagram is represented as a *birth-death process*.

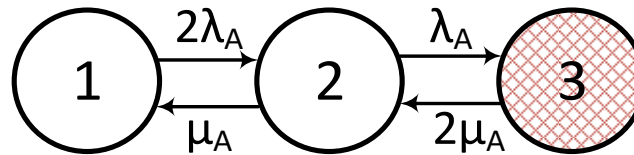

$$P_1 \left(1 + \frac{2\lambda_A}{\mu_A} + \frac{\lambda_A^2}{\mu_A^2} \right) = 1 \Rightarrow P_1 = \frac{\mu_A^2}{(\lambda_A + \mu_A)^2}, P_2 = \frac{2\lambda_A \cdot \mu_A}{(\lambda_A + \mu_A)^2}$$

$$A = P_1 + P_2 = \frac{\mu_A(\mu_A + 2\lambda_A)}{(\lambda_A + \mu_A)^2}$$

Repairable Systems

Naturally, the state-space method can be applied for non-repairable systems as well.

However, this approach is appropriate only in the case of complex redundancy configuration, not covered by previously introduced formulae.

Moreover, the state-space method allows us to find the *MTTF* of repairable systems.

Repairable Systems

Let's compare the following equations:

$$T = \int_0^{\infty} P(t) dt \qquad P(s) = \int_0^{\infty} P(t) e^{-st} dt$$

The left one is the formula for the *MTTF* of non-repairable system where reliability function is regarded as the probability of system being in operable state.

The right equation is the *Laplace transform*.

Repairable Systems

$$T = \int_0^{\infty} P(t) dt$$

$$P(s) = \int_0^{\infty} P(t) e^{-st} dt$$

It's obvious that $P(s = 0) = T$.

The *mean sojourn time* (*mean waiting time*) for a certain state in the state-transition diagram is evaluated as a Laplace transform of the probability of being in that state, assuming $s = 0$.

Repairable Systems

The algorithm for the MTTF calculation is as follows:

1. Obtain the system of equations in the form of Laplace transform.
2. Exclude from the system the equations which describe inoperable states.
3. Exclude from the remaining equations all terms which contain the probabilities of inoperable states.
4. Replace $P_i(s)$ with T_i .
5. Set $s = 0$.
6. Solve for T_i .
7. Find $\sum T_i$.

Repairable Systems

To provide an example, we consider the previous system - hot redundancy with two identical components:

$$\begin{cases} sP_1(s) = -2\lambda_A P_1(s) + \mu_A P_2(s) + 1 \\ sP_2(s) = 2\lambda_A P_1(s) - (\lambda_A + \mu_A)P_2(s) + 2\mu_A P_3(s) \\ sP_3(s) = \lambda_A P_2(s) - 2\mu_A P_3(s) \end{cases}$$

$$\begin{cases} 0 = -2\lambda_A T_1 + \mu_A T_2 + 1 \\ 0 = 2\lambda_A T_1 - (\lambda_A + \mu_A)T_2 \end{cases}$$

$$\begin{cases} 2\lambda_A T_1 - \mu_A T_2 = 1 \\ (\lambda_A + \mu_A)T_2 = 2\lambda_A T_1 \end{cases}$$

$$\begin{cases} T_2 = \frac{2\lambda_A}{\lambda_A + \mu_A} T_1 \\ 2\lambda_A T_1 - \mu_A T_2 = 1 \end{cases} \quad \begin{cases} T_1 = \frac{\lambda_A + \mu_A}{2\lambda_A^2} \\ T_2 = \frac{1}{\lambda_A} \end{cases} \quad T = T_1 + T_2 = \frac{3\lambda_A + \mu_A}{2\lambda_A^2}$$

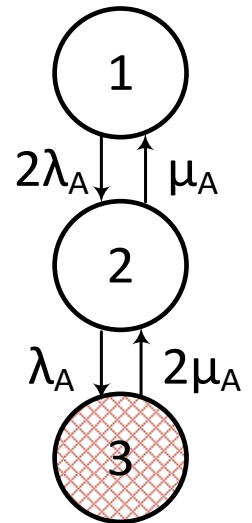

Repairable Systems

Ex.: The system consists of 2 subsystems in series.

The first one has 2 identical components A with a warm standby redundancy.

The second one is a 2-out-of-3 system with identical components B.

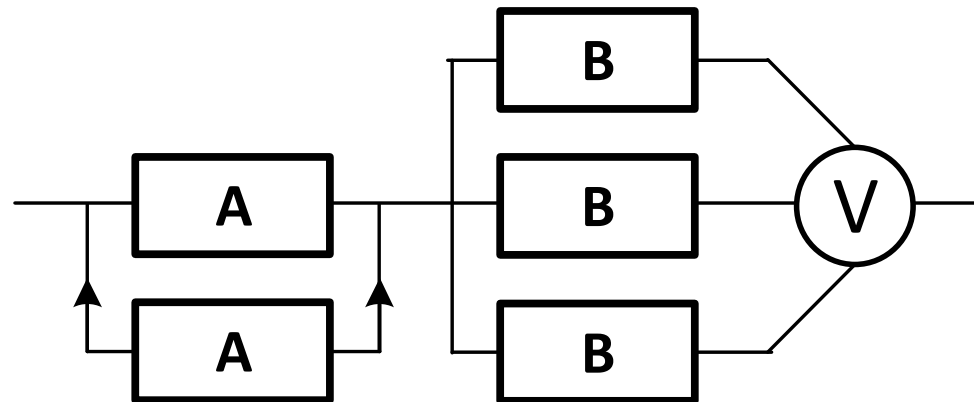

Draw a state-transition diagram for the system.



Repairable Systems

At first, let's draw transitions representing failures:

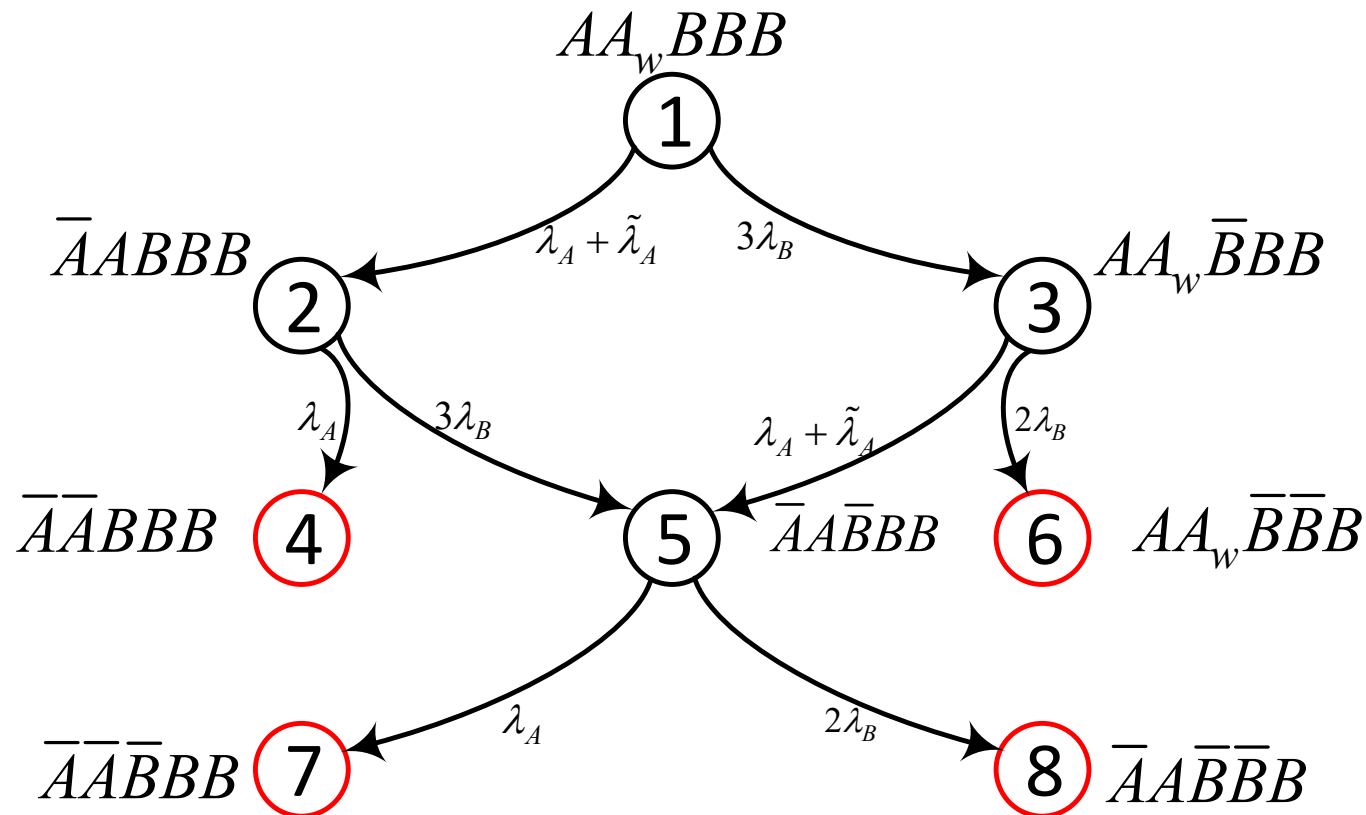

Repairable Systems

Now, let's complete the graph with transitions representing recoveries:

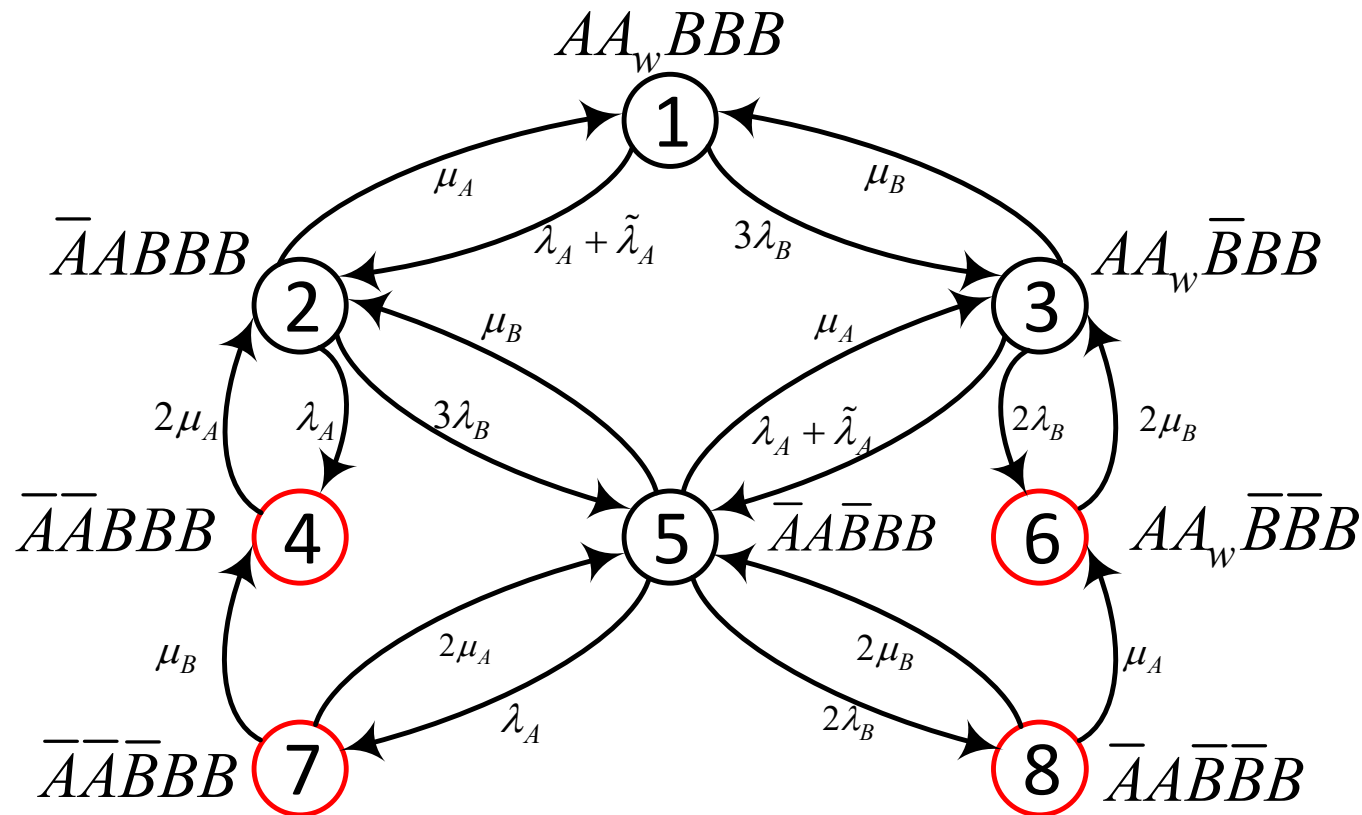

Repairable Systems

Next, let's write down the system of differential equations that describes the obtained graph:

$$p'_1(t) = -(\lambda_A + \tilde{\lambda}_A + 3\lambda_B)p_1(t) + \mu_A p_2(t) + \mu_B p_3(t)$$

$$p'_2(t) = (\lambda_A + \tilde{\lambda}_A)p_1(t) - (\lambda_A + 3\lambda_B + \mu_A)p_2(t) + 2\mu_A p_4(t) + \mu_B p_5(t)$$

$$p'_3(t) = 3\lambda_B p_1(t) - (\lambda_A + \tilde{\lambda}_A + 2\lambda_B + \mu_B)p_3(t) + \mu_A p_5(t) + 2\mu_B p_6(t)$$

$$p'_4(t) = \lambda_A p_2(t) - 2\mu_A p_4(t) + \mu_B p_7(t)$$

$$p'_5(t) = 3\lambda_B p_2(t) + (\lambda_A + \tilde{\lambda}_A)p_3(t) - (\lambda_A + 2\lambda_B + \mu_A + \mu_B)p_5(t) + 2\mu_A p_7(t) + 2\mu_B p_8(t)$$

$$p'_6(t) = 2\lambda_B p_3(t) - 2\mu_B p_6(t) + \mu_A p_8(t)$$

$$p'_7(t) = \lambda_A p_5(t) - (2\mu_A + \mu_B)p_7(t)$$

$$p'_8(t) = 2\lambda_B p_5(t) - (\mu_A + 2\mu_B)p_8(t)$$



Repairable Systems

The Laplace transform of the obtained system is as follows:

$$sP_1(s) = -(\lambda_A + \tilde{\lambda}_A + 3\lambda_B)P_1(s) + \mu_A P_2(s) + \mu_B P_3(s) + \mathbf{1}$$

$$sP_2(s) = (\lambda_A + \tilde{\lambda}_A)P_1(s) - (\lambda_A + 3\lambda_B + \mu_A)P_2(s) + 2\mu_A P_4(s) + \mu_B P_5(s) + \mathbf{0}$$

$$sP_3(s) = 3\lambda_B P_1(s) - (\lambda_A + \tilde{\lambda}_A + 2\lambda_B + \mu_B)P_3(s) + \mu_A P_5(s) + 2\mu_B P_6(s) + \mathbf{0}$$

$$sP_4(s) = \lambda_A P_2(s) - 2\mu_A P_4(s) + \mu_B P_7(s) + \mathbf{0}$$

$$sP_5(s) = 3\lambda_B P_2(s) + (\lambda_A + \tilde{\lambda}_A)P_3(s) - (\lambda_A + 2\lambda_B + \mu_A + \mu_B)P_5(s) + 2\mu_A P_7(s) + 2\mu_B P_8(s) + \mathbf{0}$$

$$sP_6(s) = 2\lambda_B P_3(s) - 2\mu_B P_6(s) + \mu_A P_8(s) + \mathbf{0}$$

$$sP_7(s) = \lambda_A P_5(s) - (2\mu_A + \mu_B)P_7(s) + \mathbf{0}$$

$$sP_8(s) = 2\lambda_B P_5(s) - (\mu_A + 2\mu_B)P_8(s) + \mathbf{0}$$



Repairable Systems

Since the system is operable when it is in the 1st, 2nd, 3rd, or 5th state, the point availability function is

$$AV(t) = p_1(t) + p_2(t) + p_3(t) + p_5(t),$$

or, alternatively,

$$AV(t) = 1 - p_4(t) + p_6(t) + p_7(t) + p_8(t).$$



Repairable Systems

The system of equations for the steady-state solution:

$$0 = -(\lambda_A + \tilde{\lambda}_A + 3\lambda_B)p_1 + \mu_A p_2 + \mu_B p_3$$

$$0 = (\lambda_A + \tilde{\lambda}_A)p_1 - (\lambda_A + 3\lambda_B + \mu_A)p_2 + 2\mu_A p_4 + \mu_B p_5$$

$$0 = 3\lambda_B p_1 - (\lambda_A + \tilde{\lambda}_A + 2\lambda_B + \mu_B)p_3 + \mu_A p_5 + 2\mu_B p_6$$

$$0 = \lambda_A p_2 - 2\mu_A p_4 + \mu_B p_7$$

$$0 = 3\lambda_B p_2 + (\lambda_A + \tilde{\lambda}_A)p_3 - (\lambda_A + 2\lambda_B + \mu_A + \mu_B)p_5 + 2\mu_A p_7 + 2\mu_B p_8$$

$$0 = 2\lambda_B p_3 - 2\mu_B p_6 + \mu_A p_8$$

$$0 = \lambda_A p_5 - (2\mu_A + \mu_B)p_7$$

~~$$0 = 2\lambda_B p_5 - (\mu_A + 2\mu_B)p_8$$~~

$$1 = p_1 + p_2 + p_3 + p_4 + p_5 + p_6 + p_7 + p_8$$



Repairable Systems

Since the system is operable when it is in the 1st, 2nd, 3rd, or 5th state, the steady-state availability is

$$AV_{steady} = p_1 + p_2 + p_3 + p_5,$$

or, alternatively,

$$AV_{steady} = 1 - p_4 + p_6 + p_7 + p_8.$$



Repairable Systems

Let's transform the graph by removing all inoperable states and related outgoing arcs:

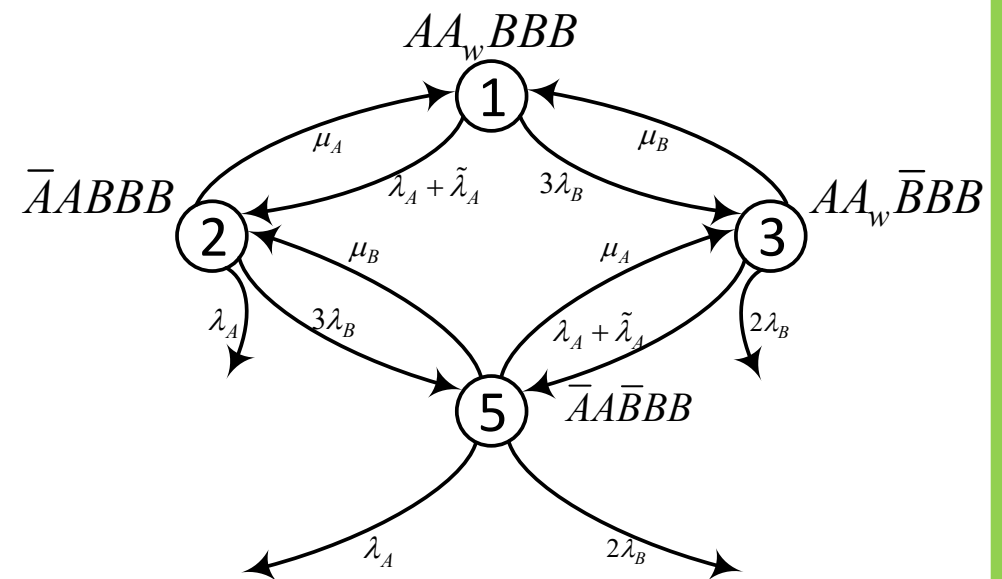
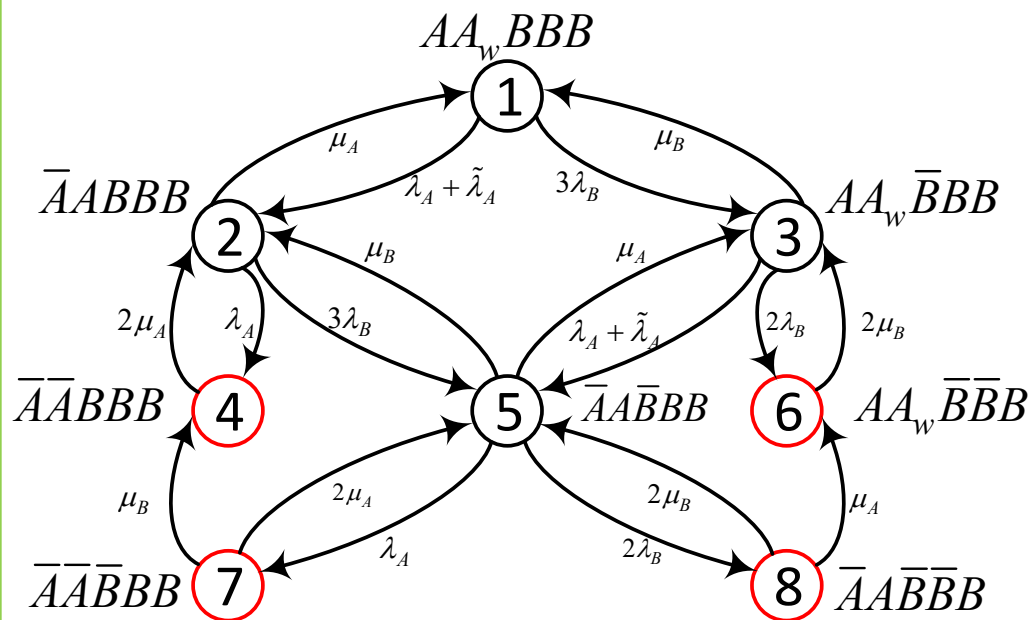

Repairable Systems

Now we can write down the system of equations for the calculation of the mean time to the system failure:

$$sP_1(s) = -(\lambda_A + \tilde{\lambda}_A + 3\lambda_B)P_1(s) + \mu_A P_2(s) + \mu_B P_3(s) + 1$$

$$sP_2(s) = (\lambda_A + \tilde{\lambda}_A)P_1(s) - (\lambda_A + 3\lambda_B + \mu_A)P_2(s) + 2\mu_A P_4(s) + \mu_B P_5(s) + 0$$

$$sP_3(s) = 3\lambda_B P_1(s) - (\lambda_A + \tilde{\lambda}_A + 2\lambda_B + \mu_B)P_3(s) + \mu_A P_5(s) + 2\mu_B P_6(s) + 0$$

$$~~sP_4(s) = \lambda_A P_2(s) - 2\mu_A P_4(s) + \mu_B P_7(s) + 0~~$$

$$sP_5(s) = 3\lambda_B P_2(s) + (\lambda_A + \tilde{\lambda}_A)P_3(s) - (\lambda_A + 2\lambda_B + \mu_A + \mu_B)P_5(s) + 2\mu_A P_7(s) + 2\mu_B P_8(s) + 0$$

$$~~sP_6(s) = 2\lambda_B P_3(s) - 2\mu_B P_6(s) + \mu_A P_8(s) + 0~~$$

$$~~sP_7(s) = \lambda_A P_5(s) - (2\mu_A + \mu_B)P_7(s) + 0~~$$

$$~~sP_8(s) = 2\lambda_B P_5(s) - (\mu_A + 2\mu_B)P_8(s) + 0~~$$



Repairable Systems

Replacing $P_i(s)$ with T_i , we get

$$0 = -(\lambda_A + \tilde{\lambda}_A + 3\lambda_B)T_1 + \mu_A T_2 + \mu_B T_3 + 1$$

$$0 = (\lambda_A + \tilde{\lambda}_A)T_1 - (\lambda_A + 3\lambda_B + \mu_A)T_2 + 2\mu_A T_4 + \mu_B T_5$$

$$0 = 3\lambda_B T_1 - (\lambda_A + \tilde{\lambda}_A + 2\lambda_B + \mu_B)T_3 + \mu_A T_5$$

$$0 = 3\lambda_B T_2 + (\lambda_A + \tilde{\lambda}_A)T_3 - (\lambda_A + 2\lambda_B + \mu_A + \mu_B)T_5$$

Solving the system for T_i , we obtain the mean time to the system failure as

$$MTTF = T_1 + T_2 + T_3 + T_5$$

Homework Assignment 2

1. For the system with the RBD, according to your variant,
 - a) construct a state-transition diagram (graph), denoting states with markings, describing operable/failed components, and transitions – with related rates;
 - b) write down the system of equations, describing the graph in Laplace transform domain;
 - c) plot the point availability function of the system;
 - d) find the steady-state availability by solving the system of equations (6 digits after decimal point);
 - e) find the mean time to the system failure.

2. Repeat 1b) – 1e), assuming that the system at $t = 0$ could be in any operable state with an equal probability.

Homework Assignment 2

8Т91		№
1	Балахнин Илья Александрович	1.1
2	Балухта Алексей Игоревич	4.3
3	Долгих Владимир Алексеевич	2.2
4	Кирсанов Никита Артурович	7.4
5	Колотихин Евгений Иванович	9.1
6	Ларина Анастасия Валерьевна	5.1
7	Лесных Глеб Игоревич	2.1
8	Макев Адиль Нурланович	10.2
9	Оздоев Рафаэль Залимханович	9.2
10	Пешков Никита Сергеевич	1.2
11	Рыбин Владислав Евгеньевич	5.4
12	Сандул Андрей Анатольевич	9.3
13	Стрельникова Виктория Анатольевна	8.2
14	Суворов Данил Владиславович	3.2
15	Сурков Данила Сергеевич	4.1
16	Тятюшкин Данил Максимович	6.1
17	Черкасов Данил Дмитриевич	6.2

8Т92		№
1	Акулов Игорь Романович	3.1
2	Ароян Эдвард Варданович	10.3
3	Белоусова Анастасия Александровна	10.4
4	Бузмаков Илья Дмитриевич	1.3
5	Гурбанов Мекан	5.2
6	Данилюк Егор Дмитриевич	4.2
7	Долгушин Егор Евгеньевич	7.2
8	Жгута Вадим	8.1
9	Киргефнер Михаил Сергеевич	8.3
10	Курманов Станислав Анатольевич	9.4
11	Мамонтов Илья Сергеевич	10.1
12	Маракин Данил Денисович	6.4
13	Медведева Елизавета Васильевна	2.3
14	Мирошников Данил Александрович	3.4
15	Назыров Роман Павлович	3.3
16	Неволина Елена Сергеевна	8.4
17	Парипко Виктор Олегович	1.4
18	Рачковский Святослав Максимович	5.3
19	Салпыков Дамир Миржанович	7.3
20	Сладков Максим	2.4
21	Солодкин Алексей Дмитриевич	6.3
22	Уточкин Сергей Вячеславович	7.1
23	Щербашин Никита Геннадьевич	4.4

Homework Assignment 2

1

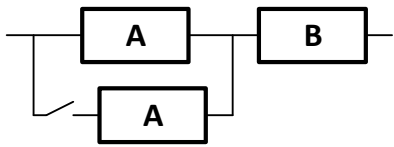

2

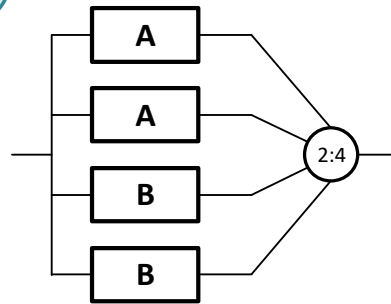

3

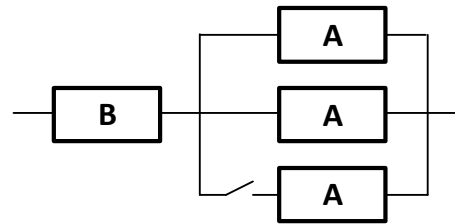

4

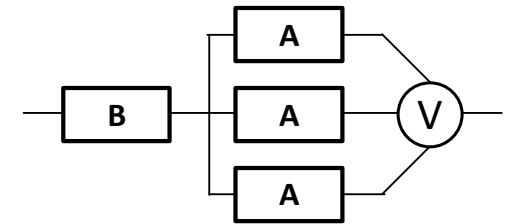

5

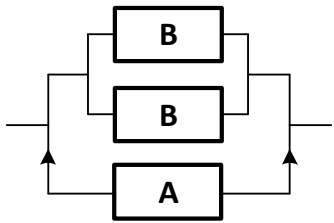

6

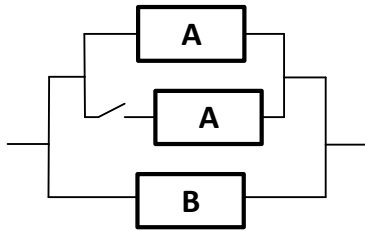

7

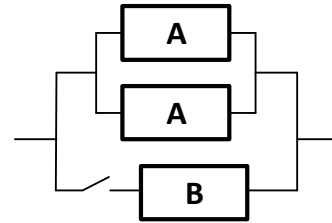

8

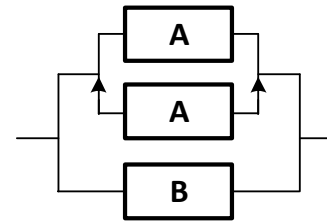

9

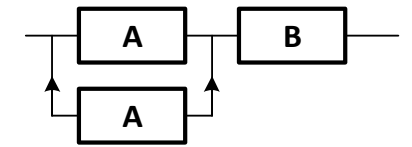

10

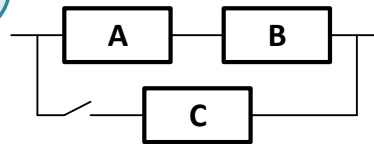

Homework Assignment 2

Схема	Вариант	А			В	
		λ_A, h^{-1}	$\lambda_{A_{SB}}, h^{-1}$	μ_A, h^{-1}	λ_B, h^{-1}	μ_B, h^{-1}
1	1	0,001		0,015	0,0004	0,01
	2	0,0008		0,01	0,0001	0,008
	3	0,002		0,02	0,0005	0,015
	4	0,0006		0,008	0,0002	0,025
2	1	0,001		0,01	0,00125	0,015
	2	0,0008		0,004	0,001	0,005
	3	0,00015		0,006	0,0008	0,003
	4	0,0005		0,003	0,0002	0,0025
3	1	0,001		0,003	0,0002	0,003
	2	0,0008		0,0025	0,00025	0,003
	3	0,0004		0,005	0,0001	0,008
	4	0,0015		0,004	0,0001	0,004
4	1	0,001		0,02	0,0002	0,008
	2	0,0004		0,008	0,0001	0,02
	3	0,002		0,01	0,0005	0,015
	4	0,0005		0,01	0,001	0,05
5	1	0,0006	0,00006	0,006	0,001	0,005
	2	0,0005	0,0001	0,005	0,0006	0,0025
	3	0,0003	0,00004	0,0008	0,0005	0,001
	4	0,0008	0,00002	0,005	0,0015	0,001

Homework Assignment 2

Схема	Вариант	А			В		С	
		λ_A, h^{-1}	$\lambda_{A_{SB}}, h^{-1}$	μ_A, h^{-1}	λ_B, h^{-1}	μ_B, h^{-1}	λ_C, h^{-1}	μ_C, h^{-1}
6	1	0,001		0,005	0,0006	0,004		
	2	0,0006		0,0025	0,0005	0,0015		
	3	0,0005		0,0015	0,0003	0,008		
	4	0,0015		0,001	0,0008	0,005		
7	1	0,002		0,006	0,0006	0,008		
	2	0,001		0,003	0,0005	0,0025		
	3	0,003		0,004	0,001	0,0025		
	4	0,004		0,004	0,0015	0,002		
8	1	0,0006	0,00015	0,0025	0,001	0,003		
	2	0,002	0,00005	0,002	0,001	0,004		
	3	0,0025	0,0008	0,003	0,0015	0,002		
	4	0,001	0,0002	0,0025	0,004	0,004		
9	1	0,0006	0,00015	0,01	0,0001	0,025		
	2	0,002	0,0001	0,0025	0,0001	0,008		
	3	0,001	0,0002	0,003	0,0003	0,005		
	4	0,0008	0,0006	0,0025	0,0001	0,004		
10	1	0,001		0,006	0,0006	0,005	0,0002	0,002
	2	0,0008		0,004	0,0005	0,003	0,0002	0,0015
	3	0,0015		0,003	0,0006	0,004	0,001	0,0025
	4	0,0025		0,003	0,0008	0,002	0,0015	0,004